

State of stress assessment for the Picote II underground powerhouse design

J. Muralha & L. Lamas

National Laboratory for Civil Engineering (LNEC), Lisbon, Portugal

C. Esteves

EDP, Porto, Portugal

ABSTRACT

The paper presents a description of the Picote II site, the objectives of the study that was carried out to assess the in situ state of stress in the rock mass, details of the testing programme and the methodology used for its interpretation. An overcoring testing programme was performed at the design stage, and a specific methodology was developed for the global interpretation of the test results, making use of a numerical model and considering the effect of the existing canyon on the stress field. This enabled to make recommendations regarding the initial stress field to consider in the design of the powerhouse cavern.

Owing to the scarce information obtained at the design stage and to the high values of the calculated horizontal stresses, it was decided to perform additional stress measurement tests, using small flat jacks, once construction started and excavation of the adits reached the proximity of the underground powerhouse. Numerical simulations were also done for its interpretation and they confirmed the stress levels obtained at the design stage. The monitoring scheme implemented in the powerhouse cavern includes instrumentation to measure stress changes, which will occur during the excavation. Finally, the significance of the state of stress assessment to the powerhouse design and to the interpretation of monitoring data collected during construction is discussed.

1 INTRODUCTION

The Picote hydroelectric scheme, built 50 years ago, is located in the North-East of Portugal, in a canyon excavated by the Douro River. The Picote II project, which is now under construction, corresponds to repowering the Picote scheme and includes a new hydraulic circuit and a new underground powerhouse.

The designer included in the site investigation tests for determination of the in situ state of stress, to be used as input to the numerical models of the underground structures. At the design stage, six STT (strain tensor tube) overcoring tests were carried out in 2 boreholes. A specific methodology was used for global analysis of the test results, in order to obtain the most likely stress field.

Owing to the relatively scarce information obtained at the design phase and to the high horizontal stresses that were determined, the designer decided to perform additional stress measurement tests, using small flat jacks, once construction started and excavation of the adits reached the proximity of the underground powerhouse. Having in mind the influence of high in situ stresses on the behaviour of the powerhouse cavern, STT cells were also included in its monitoring scheme.

2 THE PICOTE II HYDROELECTRIC SCHEME

The hydroelectric potential of the international stretch of the Douro River exploited by Portugal is made by three power plants in cascade: Miranda, Picote, and Bemposta, (Figure 1), all built in the 50 and 60 decades of the 20th century (EDP, 2005). At this location the Douro valley is narrow and deep (Figure 2). The reservoirs have small capacities and are unable to regulate the incoming flows.

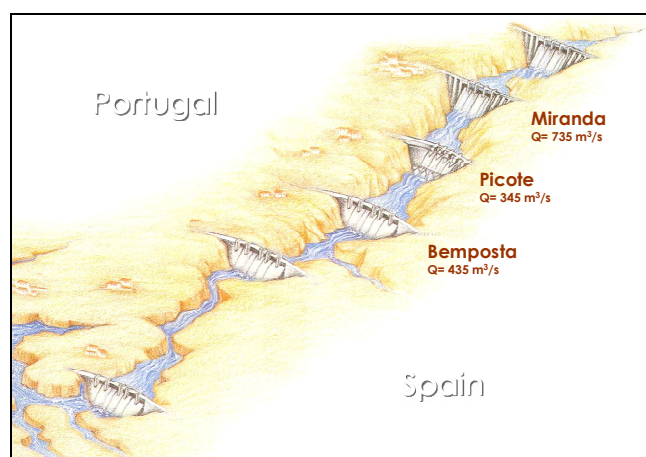

Figure 1. International stretch of Douro river cascade



Figure 2. Downstream view of the valley at Picote dam.

The three above mentioned hydropower plants were originally designed for levels of turbinning flows that nowadays are considered low. In Picote, the total discharge is only 1.5 times higher than the average flow of the river, which causes increased spillages during the wet periods, whenever the turbinning capacity is exceeded by the affluences. This situation became more evident after 1995, with the conclusion of the Miranda re-powering project. Picote re-powering scheme (Picote II) will endow the power plant with a turbinning capacity similar to Miranda's, which obviates the described issue.

The original scheme consists mainly of a concrete arch dam and an underground powerhouse with a hydraulic circuit in the right bank of the river. The re-powering scheme will also be constructed in the right bank, close to and surrounding the existing power plant. Main elements are the hydraulic circuit (a 300 m long headrace tunnel and a 150 m long tailrace tunnel), an underground powerhouse cavern and several adits. Access tunnels, connections and ventilation adits total 1,700 m of linear excavation. The shaft for cables and ventilation is 180 m high (Figure 3). The total excavation volume is 280,000 m³.

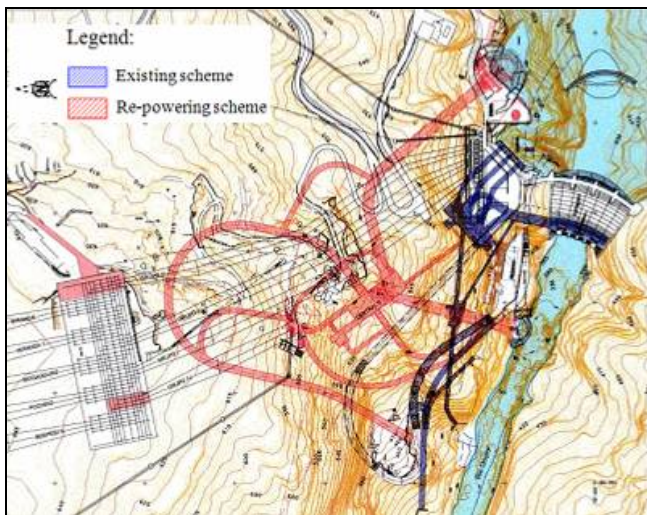

Figure 3. Plan showing the layouts of existing scheme (in blue) and re-powering scheme (in red).

The new powerhouse cavern is 68 m long, 23 m wide between sidewalls and 58 m high at the turbine hall and 26 m at the assembly area. The large, 600 ton turbine, with a 400 m³/s capacity, conditioned the cavern width. A reinforced concrete arch roof had to be built in order to

support the crane beam that handles the turbine. The cavern is located about 150 m below surface and will be built only 80 m away from the existing one.

The Picote hydropower plant is located in the Miranda plateau, in a zone where the Douro River flows through a valley with a canyon configuration, with almost vertical banks. The river is aligned with a WNW-ESE fault and porphyritic granite is the principal local lithology. Interpretation of geological structures was based on aerial photography, and on local observation of existing unlined adits. Most of the existing power plant excavations were carried out in a good quality rock mass.

The site characterization included analysis of geological and geotechnical information related with the design and construction of the existing hydropower plant and also with the studies conducted since the early project stages of the re-powering scheme. To study the rock mass at the new cavern location, several boreholes were drilled (Figure 4) and an investigation programme consisting of in situ and laboratory tests was conducted by LNEC (2006). It included stress measurements by overcoring (STT) and dilatometer tests in the field, and UCS, ultrasound, brazilian, triaxial and shear tests in the laboratory.

Since the concrete arch structure of the roof of the powerhouse cavern is constructed before an important part of the cavern lower part benching, an important portion of the convergences is expected to load this structure. The effects of this "convergence-load" are, actually, of much more significance than the effects resulting from handling the turbine (Esteves *et al.*, 2008). This fact justifies the importance and the need to adequately characterize the in situ state of stress.

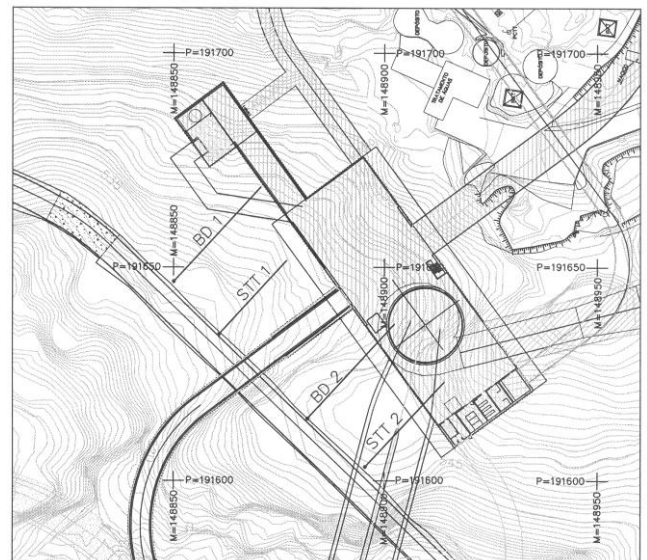

Figure 4: Location of boreholes in the new powerhouse zone

3 STRESSES OBTAINED FROM OVERCORING

3.1 Overcoring test results

STT overcoring tests use a 2 mm thick epoxy resin hollow cylinder with 10 strain gauges embedded at its mid thickness. The strain gauges are positioned normal to the faces of a regular icosahedron, thus sampling homogeneously the 3D space (Pinto, 1983).

STT tests follow similar procedures as other overcoring tests. The cell is cemented in a 37 mm diameter borehole and the in situ stresses are relieved by overcoring with a larger diameter, thus obtaining a core of approximately 120 mm diameter. Strains are measured before and after overcoring and the stresses are calculated using the elastic constants obtained in a biaxial test of the recovered core with the cell inside.

Three STT tests were carried out in each of the 2 boreholes (STT1 and STT2). These boreholes, parallel and 50 m apart from each other, were drilled from an existing access adit and dip at approximately 70° towards the new powerhouse (Figure 4). The tests were carried out at the following depths: STT1 – 39.80 m; 66.10 m and 78.35 m; STT2 – 41.00 m; 60.60 m and 77.45 m.

Only 4 cores could be recovered from the 6 overcoring tests. Biaxial tests, with confining pressures up to 10 MPa, were performed in these cores to obtain the Young’s modulus (E) and the Poisson’s ratio (ν) of the rock. The assumption of isotropy is reasonable in the good quality Picote granite. Figure 5 shows graphs of confining pressure *versus* strains for one of the biaxial tests. The results obtained are presented in Table 1.

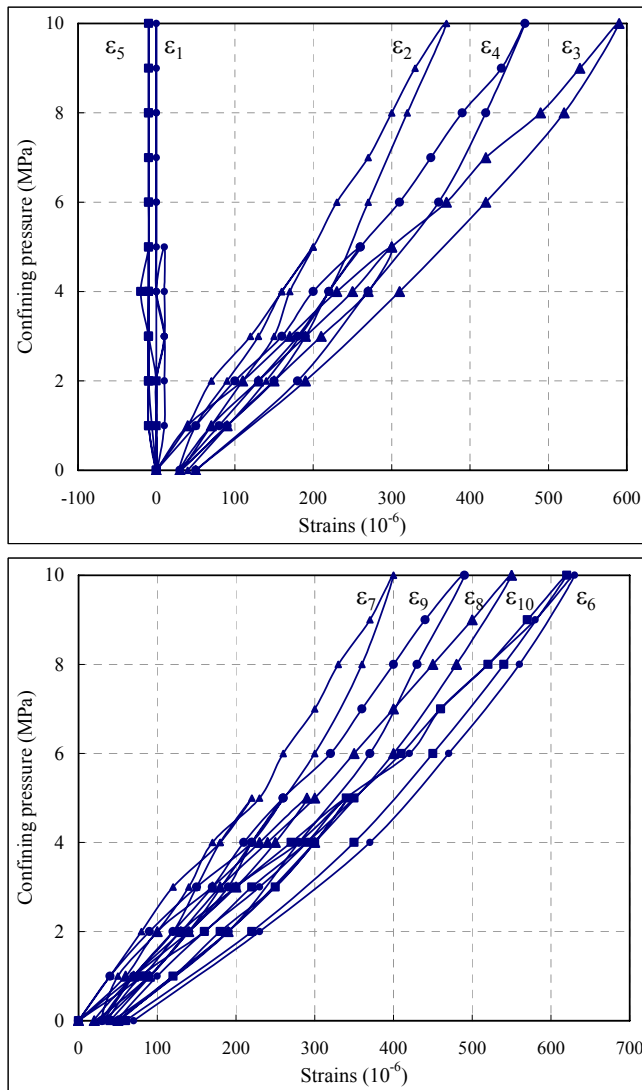

Figure 5: Biaxial test - STT1 at 66.10 m

The Young’s modulus presents a small dispersion around 40 GPa and the Poisson’s ratio presents a higher

variability. For analysis of the overcoring tests when no core was recovered, the following values were used: E = 40 GPa, ν = 0.20.

Borehole Depth (m)	STT1		STT2	
	66.10	78.35	60.60	77.45
E (GPa)	38.4	41.5	41.3	39.3
ν	0.16	0.16	0.26	0.35

Figure 6 presents the strains obtained during one of the overcoring tests. Using the values of the elastic constants and the strains determined in the overcoring tests, the stresses were calculated using a semi-analytical methodology (Pedro and França, 1972). The principal stresses and the principal directions are shown in Figures 7 and 8 for the 2 boreholes.

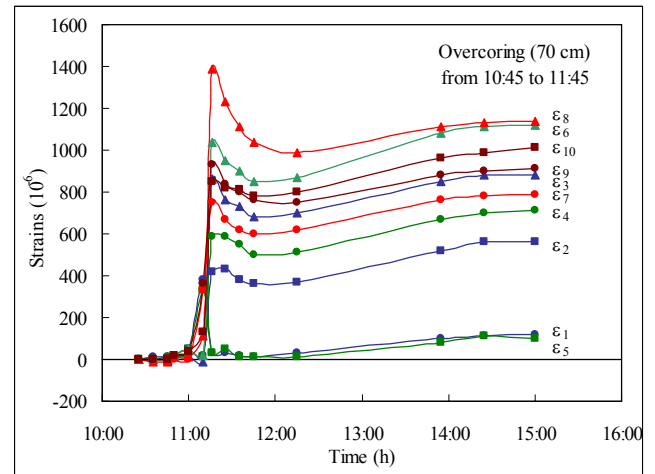

Figure 6: Overcoring strains - STT1 at 66.10 m

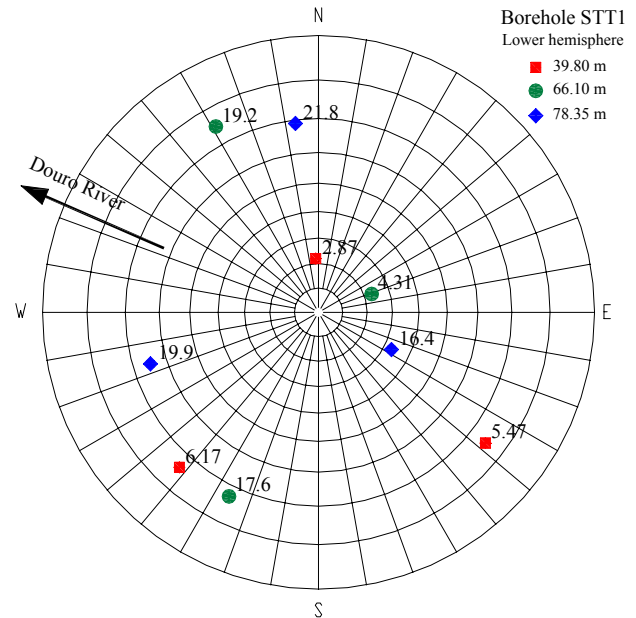

Figure 7: Stresses calculated for the tests in borehole STT1

In all tests, one of the principal stresses is approximately in the direction of the borehole. The other 2 are approximately parallel and normal to the powerhouse cavern axis. In some tests the stress levels are considerably higher than initially expected. This is the case of the test in STT1 at 78.35 m with an almost hydrostatic stress

of around 20 MPa. As usual in this type of tests, the variability of the results obtained is also high.

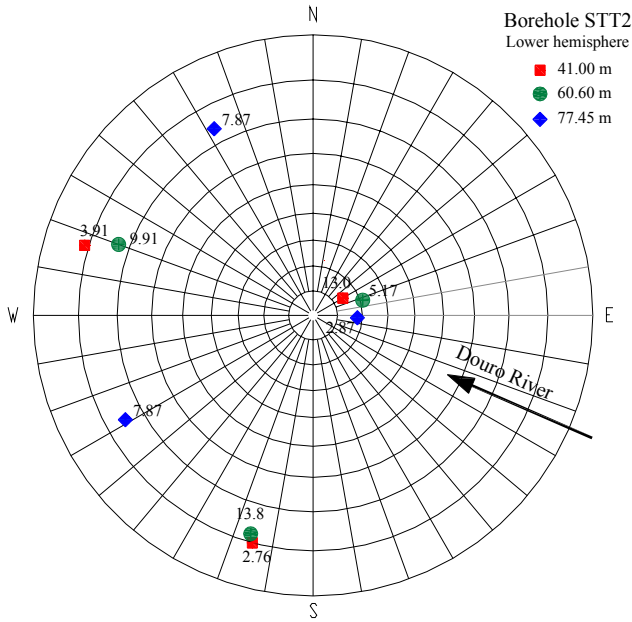

Figure 8: Stresses calculated for the tests in borehole STT2

3.2. Global interpretation model

For interpretation of the test results a 2D numerical model was developed, using the finite difference software FLAC (Itasca, 2005a). The rock mass is considered continuous, linear elastic, homogeneous and isotropic. The powerhouse will be aligned approximately parallel to the river. The cavern floor will be at elevation 392 m. The 2 boreholes intersect the zone of the future cavern.

The model simulates a vertical section through the future powerhouse cavern, roughly normal to the river and parallel to the 2 boreholes. The mesh (Figure 9) has 1,000 m in the horizontal direction, with an axis of symmetry on the left boundary, which represents the river bed. It has 700 m in the vertical direction, from elevations 0 m to 700 m. The mesh has 200×300 zones (elements), which in the test locations are $2.5 \text{ m} \times 1.75 \text{ m}$.

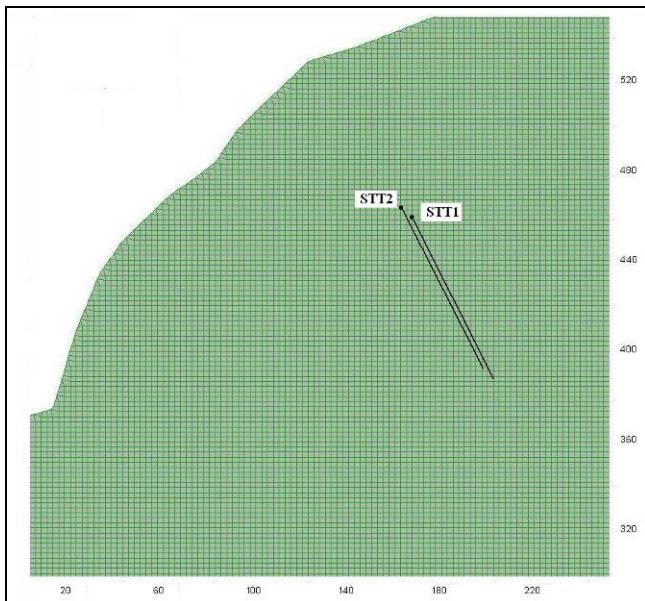

Figure 9: Mesh detail and location of the boreholes

The following assumptions were made for calculation of the in situ stresses resulting from the excavation of the valley due to the erosive action of the river:

- plane strain conditions;
- the initial vertical stress, σ_v , prior to valley excavation, is equal to the weight of the overlying rock;
- the horizontal stresses, σ_h , σ_n , respectively in the plane of the model and normal to it, prior to valley excavation, vary linearly with depth;
- σ_v , σ_h and σ_n are principal stresses.

Thus, if γ is the unit weight of the rock mass ($\gamma = 27 \text{ kN/m}^3$) and h is the depth measured from elevation 700 m, σ_v , σ_h and σ_n are given by:

$$\sigma_h = k_1 \gamma h, \quad \sigma_v = \gamma h, \quad \sigma_n = k_3 \gamma h \quad (1)$$

If we consider each of these stress components acting separately, we have 3 different loading cases E_i ($i=1,2,3$):

$$\begin{aligned} E_1 &\rightarrow \sigma_h = k_1 \gamma h & \sigma_v &= 0 & \sigma_n &= 0 \\ E_2 &\rightarrow \sigma_h = 0 & \sigma_v &= k_2 \gamma h & \sigma_n &= 0 \\ E_3 &\rightarrow \sigma_h = 0 & \sigma_v &= 0 & \sigma_n &= k_3 \gamma h \end{aligned} \quad (2)$$

The components of the state of stress (σ_{xx} , σ_{yy} , σ_{zz} and τ_{xy}) in the 6 overcoring test locations may be calculated from their values for each individual loading case, E_i , using the principle of superposition of effects, by:

$$\begin{aligned} \sigma_{xx} &= k_1 \sigma_{xx1} + k_2 \sigma_{xx2} + k_3 \sigma_{xx3} \\ \sigma_{yy} &= k_1 \sigma_{yy1} + k_2 \sigma_{yy2} + k_3 \sigma_{yy3} \\ \sigma_{zz} &= k_1 \sigma_{zz1} + k_2 \sigma_{zz2} + k_3 \sigma_{zz3} \\ \tau_{xy} &= k_1 \tau_{xy1} + k_2 \tau_{xy2} + k_3 \tau_{xy3} \end{aligned} \quad (3)$$

In order to apply this set of equations, the values of k_1 and k_3 need to be obtained. This was done using the following procedure:

- calculate σ_{xx1} , σ_{yy1} , σ_{zz1} and τ_{xy1} , using the numerical model, in the 6 test locations, for load case E_1 ;
- *idem* of σ_{xx2} , σ_{yy2} , σ_{zz2} and τ_{xy2} , for load case E_2 ;
- *idem* of σ_{xx3} , σ_{yy3} , σ_{zz3} and τ_{xy3} , for load case E_3 ;
- calculate σ_{xx} , σ_{yy} , σ_{zz} and τ_{xy} , from the overcoring test results, in the 6 test locations;
- set up the system of equations (3) for the 6 test locations (24 equations, with 2 unknowns k_1 and k_3);
- solve of the system of equations by the least squares method to obtain k_1 and k_3 .

Applying this procedure to the overcoring tests carried out for the Picote II project, the following values were determined: $k_1 = 1.70$ and $k_3 = 1.75$.

Based on this analysis, the recommendations to the designer regarding the state of stress to consider in the calculation of the powerhouse cavern were the following:

- the initial in situ state of stress should be obtained from a situation prior to the excavation of the valley, with a vertical stress equal to the weight of the overlying rock mass and with a uniform horizontal stress equal to 1.75 times the vertical stress;
- this initial in situ state of stress shall be considered for simulation of the excavation of the valley due

to the erosive effect of the river, and the resulting state of stress shall be the starting point for the calculation of the powerhouse.

Figure 10 shows the principal stresses calculated in the overcoring test locations using this procedure. Their values are presented in Table 2, where σ_{II} is always normal to the plane, *i.e.*, parallel to the river. The stresses are, clearly, very influenced by the proximity of the canyon. The ratio of σ_I (sub-horizontal) over σ_{III} (sub-vertical) is very high and varies between 4.5 and 5.1.

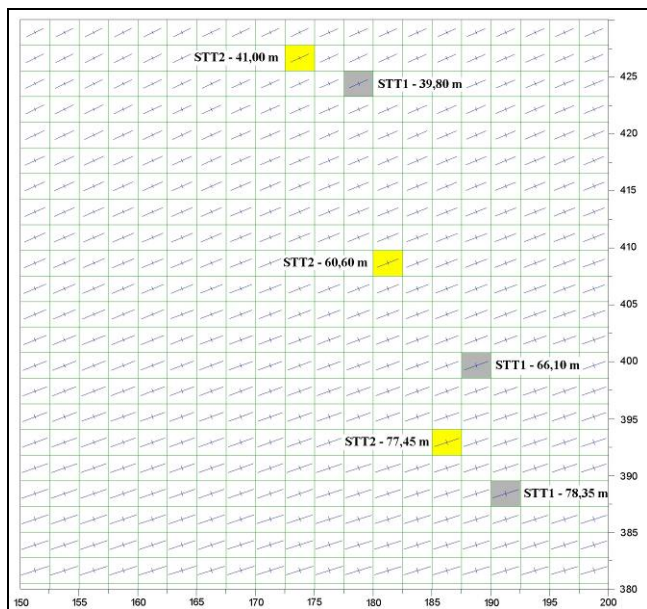

Figure 10: Stresses calculated in the overcoring test locations

Table 2: Principal stresses calculated in the test locations

Borehole	STT1			STT2		
Depth (m)	39.80	66.10	78.35	41.00	60.60	77.45
σ_I (MPa)	11.8	14.4	15.5	11.5	13.5	15.1
σ_{II} (MPa)	11.4	12.6	13.1	11.2	12.1	12.9
σ_{III} (MPa)	2.38	3.07	3.38	2.26	2.75	3.20
Dip (°)	24.5	20.2	18.4	25.3	21.9	19.3

4 STRESSES OBTAINED FROM FLAT JACKS

Owing to the relatively scarce information obtained at the design phase and to the high horizontal stresses that were determined, it was decided to perform additional stress measurements, using the SFJ (small flat jack) method, once construction started and excavation of the adits reached the proximity of the underground powerhouse. Three zones, on the walls of the adits, were chosen for testing. In each of them, four direct stress measurements forming a 45° rosette were carried out. Figure 11 is a schematic representation of the geometry of the niche existing at one of the test locations, and Figure 12 shows the back wall of the niche and the location of the slots.

Figure 13 is a plot of the results obtained in this niche. The cancellation pressure could not be reached because the capacity of the equipment is 20 MPa, but their values could be extrapolated from the curves. The principal stresses calculated on the wall plane (N30°W) were approximately horizontal and vertical: 21.7 MPa, at 330°/9° (trend/plunge) and 14.6 MPa at 150°/81°. Using a numerical model of the flat jack test geometry (Martins,

1985), values of the Young's modulus of the rock mass between 18.6 MPa and 22.3 MPa were calculated. These results did not consider the curve for the slot at 135°, with a considerably higher Young's modulus and cancellation pressure.

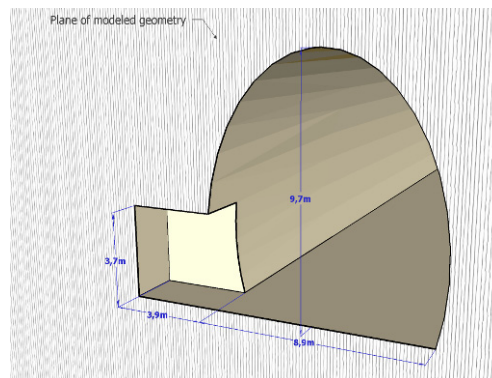

Figure 11: Schematic geometry of excavation modelled

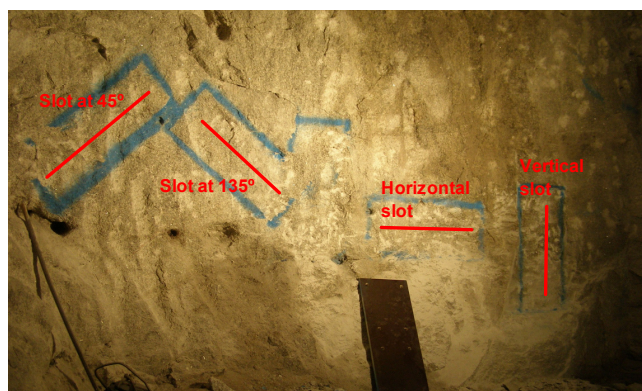

Figure 12: Location of the small flat jack tests rosette

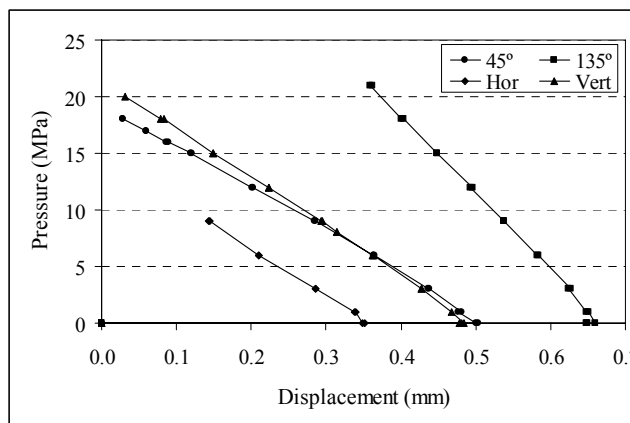

Figure 13: Results of a small flat jack tests rosette

The values of the measured stresses were compared with the results obtained from a plane-strain numerical model using the finite difference code FLAC^{3D} (Itasca, 2005b). The model simulates the excavation of the adit (with elliptic cross section) and of the niche where the SFJ tests were performed, with an initial vertical stress, σ_v , corresponding to gravitational loading and a relation between horizontal and vertical stresses $\sigma_h/\sigma_v = 4$, resulting from the overcoring tests. At the level of the niche the initial stresses are $\sigma_v = 5$ MPa and $\sigma_h = 20$ MPa.

The calculated stresses in the rock mass around the excavation are plotted in Figure 14. The vertical stress at the zone where the SFJ tests were performed is approximately 15 MPa, which is close to the experimental value.

The measured horizontal stress is approximately 4 times the initial vertical stress considered in the model, which is in agreement with the assumption used in the numerical model regarding the vertical to horizontal stress ratio.

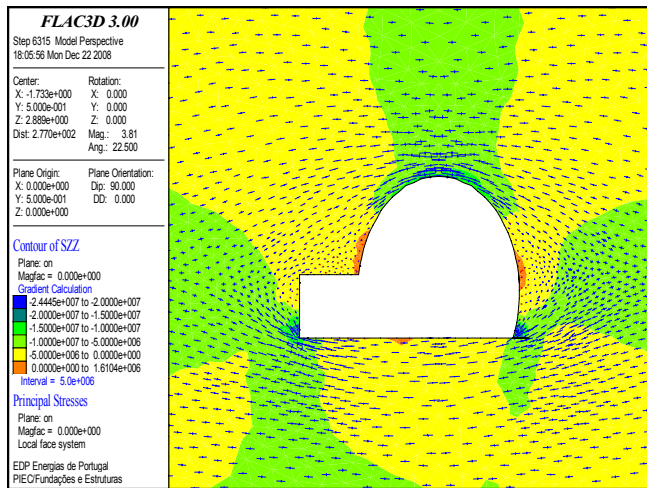

Figure 14: Vertical stress contours at the SFJ tests niche

The results obtained from the SFJ tests and their interpretation for each location confirmed, in general, the global state of stress obtained from the overcoring testing programme.

6 CONCLUSIONS

In geotechnical design, the in situ state of stress is a parameter simultaneously of great relevance and difficult to estimate. For the Picote II underground powerhouse, an initial testing programme resulted in high estimates of the horizontal stresses. Owing to these high values and to the vulnerability of the powerhouse structure to horizontal stresses, an additional testing programme was carried out after excavation reached the powerhouse vicinity. The results of the initial tests were, generally, confirmed.

The in situ state of stress used as input for the calculation model of the powerhouse was based on the values obtained from these testing programmes, namely a vertical stress equal to the weight of the overlying rock and horizontal stresses equal to four times the vertical stress.

For evaluation of the behaviour of the rock mass and of the roof concrete arch during excavation of the powerhouse, a monitoring plan was prepared and the instrumentation is being installed. Besides the usual array of instruments (such as rod extensometers in the rock mass, Carlson type extensometers in the concrete arch, Gloetzel pressure cells in the rock/concrete interface and convergence bases on the cavern walls and ceiling), three-dimensional STT strain cells were also specified. These cells will be left in the rock mass in order to measure the strain changes (and therefore the stress changes) due to the excavation process.

Figure 15 shows the triple rod extensometers to be installed around the cavern and the location of the STT cells. They will be cemented close to 2 extensometers, at a depth between 6 m and 10 m from the cavern wall, to be defined according to the quality of the rock cores obtained during drilling of the boreholes.

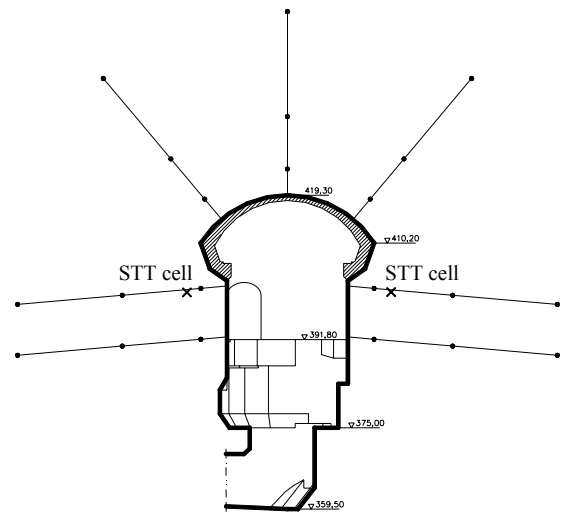

Figure 15: Monitoring of the powerhouse

The analysis of the monitoring results, performed timely as excavation progresses, will make it possible to assess the structural behaviour of the powerhouse cavern, to investigate the reasons for possible deviations from the predicted behaviour and to decide about the implementation of any measures deemed necessary to ensure safety of the construction works.

ACKNOWLEDGEMENTS

Permission from EDP - Energias de Portugal, S.A., to publish the information regarding the Picote II hydroelectric scheme is greatly acknowledged.

REFERENCES

- EDP 2005. *Hydroelectric exploitation of the international stretch of the river Douro – Picote – Repowering* (in Portuguese). Unpublished report.
- Esteves, C., Plasencia, N. & Lima, C. 2008. The application of FLAC3D on Picote II Underground Powerhouse. *Proc. 1st International FLAC/DEM Symposium*. R.D. Hart, C.L. Detournay & P.A. Cundall (eds). Itasca Consulting Group, Minneapolis.
- Itasca 2005a. *FLAC – Fast Lagrangian Analysis of Continua, Ver. 5.0, User's Manual*. Minneapolis.
- Itasca 2005b. *FLAC^{3D} – Fast Lagrangian Analysis of Continua in 3 Dimensions, Ver. 3.0, User's Manual*. Minneapolis.
- Lima, C., Plasencia, N. & Esteves, C. 2007. Picote II underground powerhouse – geotechnical characterisation and design. *Proc. 11th Congress of the ISRM*. Ribeiro e Sousa, Olalla & Grossmann (eds). Taylor & Francis, London.
- Martins, C.S. 1985. *Contribution to the study of underground structures of hydroelectric projects* (in Portuguese). Specialist thesis, LNEC, Lisbon.
- LNEC 2006. *Tests for the rock mass characterisation of the new Picote powerhouse* (in Portuguese). Report 71/06-NFOS, LNEC, Lisbon.
- Pinto J.L. 1983. *Deformability of rock masses* (in Portuguese). Research program submitted for obtaining the degree of Principal Research Officer, LNEC, Lisbon.