

COMITÉ NACIONAL ESPAÑOL DE GRANDES PRESAS

THE USE OF SOIL-ROCK MIXTURES IN DAMS IN PORTUGAL

Laura Caldeira¹
Andrea Brito²

RESUMEN: Soil-rock mixtures are being used in the construction of dam shells. The measured deformations associated to these materials have been larger than expected. This situation represents new challenges to compaction techniques and their control as well as to the determination of the characteristics of the embankment that results from the compaction method, as those characteristics suffer important changes according to the relative percentage of the existing fractions. For the execution control of the soil-rock mixtures from the Odelouca dam borrow areas, a series of vibratory compaction tests and standard compaction tests were performed to estimate reference values for the maximum dry density and optimum water content of these materials. Odelouca dam is a zoned embankment dam, 76 m high, with clayey soil at the core and weathered schist with a significant fraction of oversized particles at the shells. The results of the compaction control, as well as its behaviour during the construction phase, are herein presented.

¹ Senior Research Officer, Head of Geotechnical Department, Laboratório Nacional de Engenharia Civil, Portugal.

² PhD Student, Laboratório Nacional de Engenharia Civil, Portugal.

1. INTRODUCTION

The use, by economical and environmental reasons, of non traditional materials, such as soil-rock mixtures, in earthworks construction, brings to dam engineering new challenges. Usually, this kind of material results from the rocky bulky extraction without explosives, and it can include some oversized particles (about 0.5 m or larger).

Soil-rock mixture material must comply with the following conditions (JAE, 1998): (i) fraction retained on $\frac{3}{4}$ " (19 mm) sieve between 30% and 70%; (ii) fraction passing # 200 (0.074 mm) sieve between 12% and 40%; (iii) and the maximum particles dimension (D_{max}) lesser than $\frac{2}{3}$ of the layer thickness after compaction and not larger than 0,40 m.

The Portuguese Dam Design standard (NPB, 1993) classifies materials between soil and rockfill as transition materials (Figure 1). According to the same document, soils have a significant fraction of 2-6 mm dimension particles and eventually larger particles disseminated in fine matrix and without having any structure. Rockfill materials present sizes ranging from metric dimension, fixed by construction reasons, to clay's dimensions, and exhibiting permeability larger than 10^{-5} m/s. Finally, the transition materials, herein called soil-rock mixtures, are characterized by a significant fraction of oversized particles, sufficiently to form a structure, associated with a fine matrix. Their stress-strain behaviour is not only determined by the coarse fraction, since the fine material plays an influent part.

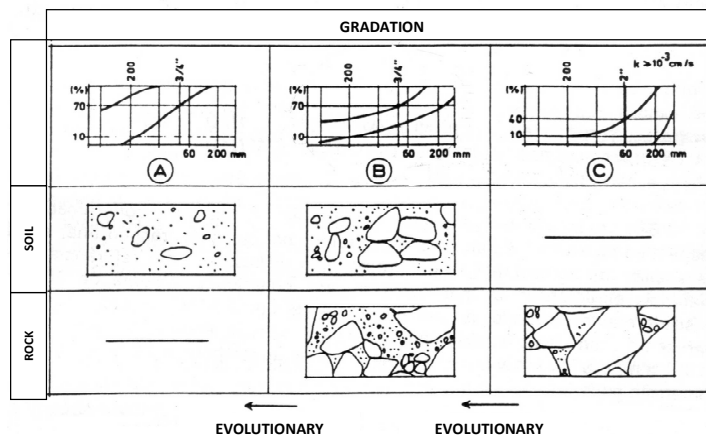

Figure 1 – Typical grain size distribution and structure of (Maranha das Neves, 1993) of: A) soils; B) soil-rock mixtures; C) rock fill.

Recently, especially in dam and road engineering, some attention has been addressed to soil-rock mixtures, due its anomalous deformation behaviour, forcing, in many cases, to corrective measures. Frequently, these materials present an evolutive nature, with a friable coarser fraction, that, with the construction process and in the operation phase, suffers a change of their nature and of their gradation.

Its mechanical properties are greatly affected by its grain size distribution, construction techniques, applied loads and environmental conditions. So, a thoroughly and comprehensive experimental investigation is needed and is under development to perceive the most important parameters related with the construction conditions and quality control, as well as short and long-term behaviour as function of the rockfill lithological constitution and soil and rock relative percentages present in the mixture. This kind of studies will converge to the calibration of existing constitutive model or to the development of a new one that integrates all the characteristics determined in the laboratory investigations.

In this paper, two dams built with this type of materials and with a defective behaviour, in terms of deformation, are described. Then, the studies already done about the quality construction control of soil-rock mixtures, aiming the performance improvement of the dams, are referred, as well as its application to a new dam – Odelouca dam. Finally, some monitoring data of the construction phase of Odelouca dam are presented.

2. SOIL-ROCK MIXTURE DAM BEHAVIOUR

In last years, the soil-rock mixtures were used in the construction of several dams in Portugal, among others, Beliche, Meimoa, Sabugal, Santa Justa, Ribeiro Grande and Arco dams. In the following, as example, the behaviour of Beliche and Meimoa dams is briefly reported.

Beliche dam was built between 1982 and 1985, in Algarve, in the South of Portugal, for irrigation and water supply purposes, with a reservoir total capacity of 47 hm³ and a height of 55 m. The dam foundation is constituted by schist and greywacke with a considerable weathering degree. The core is directly founded in the rock substrate, after removing an alluvial layer of silty sand and gravel, with a maximum thickness of 10 m at the bottom valley. For the foundation treatment, an impervious grout curtain was executed.

The dam body is essentially constituted by a central core and rockfill and soil-rock mixtures shell materials. During the construction highly weathered schist and greywacke (a soil-rock mixture) were used in the inner part of the shells, forming transition zones between the core and the outer zones of the shells (Figure 2). The materials were compacted, essentially, in dry conditions, due to the shortage of water during the summer.

A very complete monitoring system was installed to control the structural behaviour of the dam, composed of surface markers, distributed along the crest and the downstream slope, 3 inclinometers tubes, 6 internal settlement gauges (Figure 3), 28 total pressure cell groups and 56 piezometers in the embankment and in the foundation.

During the dam construction (Pardo, 2006), in winter of 1984/85, a very heavy rainfall occurred and caused large settlements of the already built embankment (Figure 4). In 1987, during the first filling of the reservoir, the dam experienced relatively important settlements at the crest, with rates of 15 to 18 mm/month, attributed to wetting-induced collapse and creep of the inner shell zones. At the end of filling, the crest settlements reached the value of 0.65 m

and the loss of freeboard was 0.50 m. The average crest settlement rate decreased to 5 mm/month at the end of the first filling.

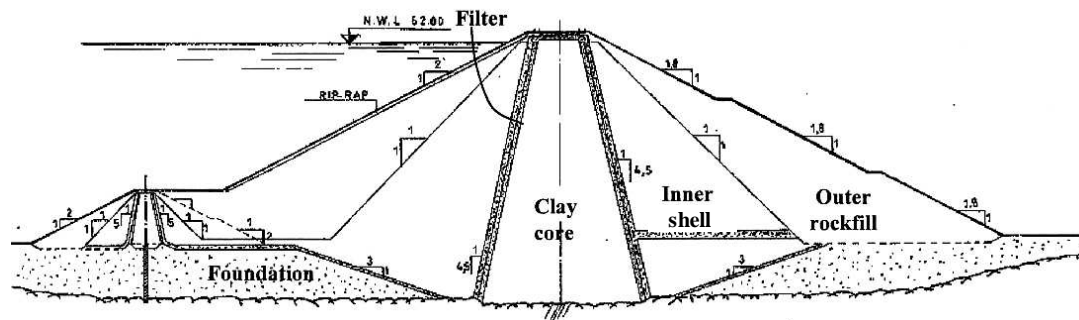

Figure 2 – Cross-section of Beliche dam

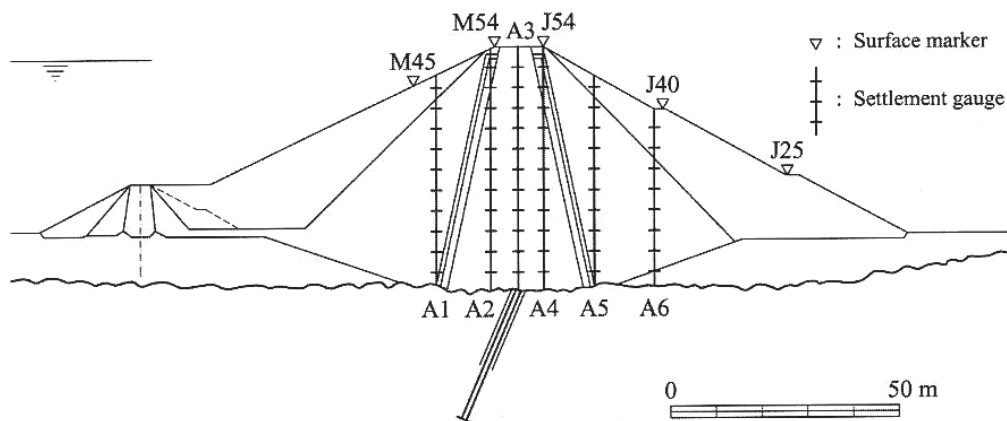

Figure 3 – Settlements gauges at cross-section 7

The surface markers located in the upstream and downstream crest alignments, at the end of the first filling, registered maximum values of horizontal displacements, respectively, of 0.18 and 0.32 m, towards downstream. As result, a longitudinal cracking of the crest surface was detected.

In November 1988, after a period of heavy rainfall, the water level at the reservoir exceeded the maximum water level in about 0.40 m. A new maximum operation level, in normal conditions, was then established at El 50.5 m (NWL= 52 m) and good quality blocks were placed upper part of the upstream slope.

In 1996, the crest settlements reached the maximum value of 0.70 m, the internal horizontal displacements the maximum value of 0.55 m, and the horizontal displacements at the crest the maximum value of 0.40 m, towards downstream.

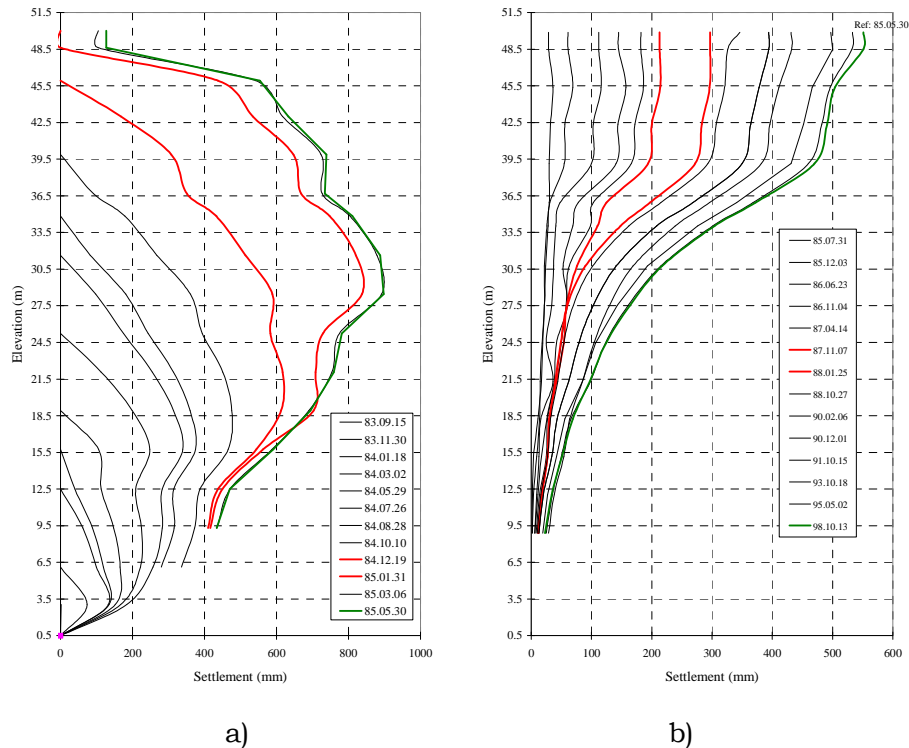

Figure 4 – Vertical displacements at A1 settlement gauge during: a) construction; b) first filling of the reservoir

To minimize the overtopping risk due to occurrence of floods larger than the one considered in the original design and to the loss of freeboard, various options were considered. It was concluded that the most convenient solution, in technical and economical terms, comprised the heightening of dam, the specification of specific operation norms and a minimum adaptation of spill way. The monitoring system was also modified, especially at the crest.

The rehabilitation works took place between August 1997 and June 1998, with the adoption of a crest elevation of 55.7 m and operation levels of $NWL=49.5$ m and $MWL=53.8$ m.

Meimoa dam was concluded in 1985, near Castelo Branco, in the central part of Portugal, for irrigation and water supply purposes, with a reservoir total capacity of 40.9 hm^3 and a height of 56 m. It is a zoned dam, with a core, constituted by clayey soils, a vertical filter and upstream and downstream shells, constituted by materials resulting from excavation (soil-rock mixtures – Figure 5).

The dam foundation is constituted by schist and greywacke highly weathered. A superficial 4 m thick layer was removed before the construction. For the foundation watertightness, an inclined grout curtain was executed from the crest.

The monitoring system, installed after construction, is composed by surface markers, distributed along the crest (upstream and downstream alignments) and the upstream and downstream slopes, 9 inclinometers tubes, 49 piezome-

ters in the embankment and in the foundation, foundations drains and a seepage weir placed at the exit of a drainage gallery.

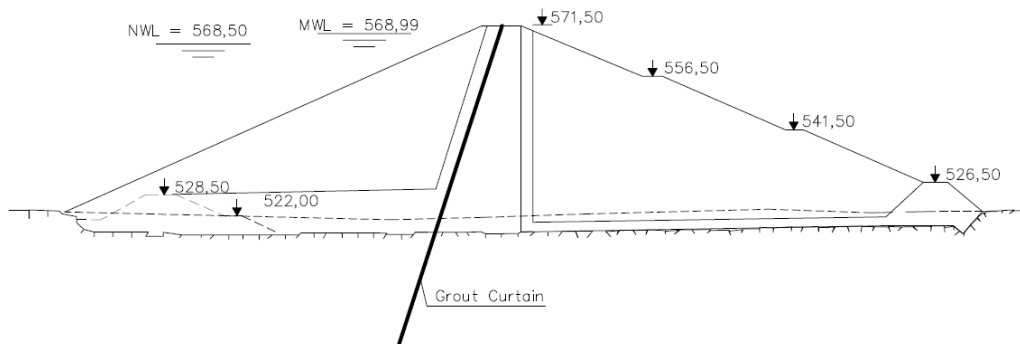

Figure 5 – Cross-section of Meimoa dam

During the first filling of the reservoir some anomalies were detected:

- An horizontal displacement, towards upstream, of the concrete beams of the downstream footway (Figure 6a));
- Longitudinal (in the upstream zone) and transversal (in the upstream and downstream footways) cracking in the crest pavement, due to differential settlements, most frequent near the abutments, where the foundations are steeper;
- Visible settlements of the embankment in relation to the top protection blocks of the monitoring equipment (piezometers and inclinometer – Figure 6b));
- Readings of water levels at piezometers installed at elevations higher than the reservoir water level;
- Large displacement rates at the surface markers and inclinometers (Figure 7 – until November 1988).



a)

b)

Figure 6 – a) Displacement of the footway beam; b) settlement of the crest pavement

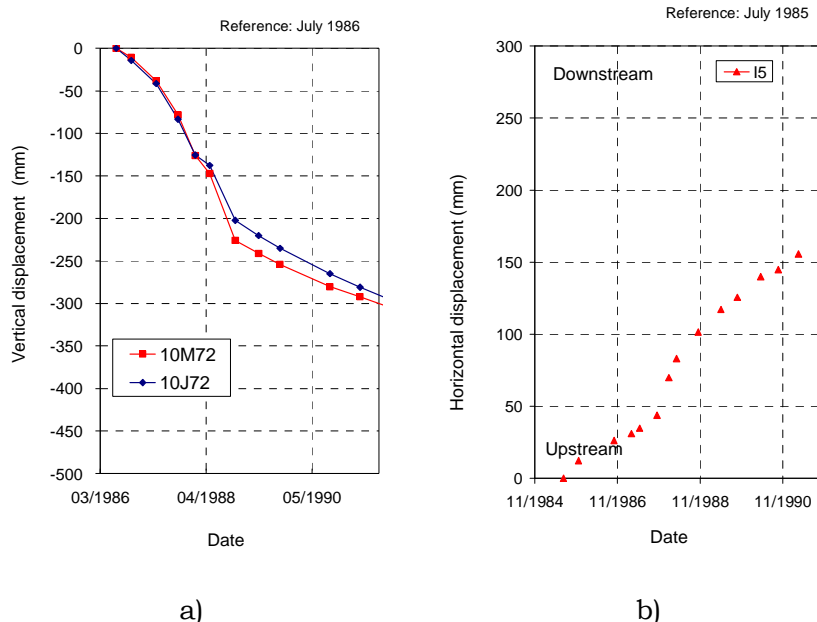

Figure 7 – Displacements during first filling a) settlements of crest markers; b) top horizontal displacement of an inclinometer

3. CONSTRUCTION QUALITY CONTROL OF SOIL-ROCK MIXTURES

The construction quality control of dams constituted by soil-rock mixtures is still a subject that needs investigation, considering that is necessary to extrapolate current test results, been reach by truncated gradation, for the construction conditions of the embankments.

Effectively, on the one hand, these materials exhibit a percentage of rockfill material, which, in the course of placing, is normally controlled by only one parameter – void ratio. On the other hand, they exhibit a percentage of soil, which is characterized by two parameters – dry unit weight and water content. Doubts arise about how soil-rock mixtures must be treated. Their behaviour depends of the relative percentage of theirs constituents, be coming close to a soil, if the fine fraction is large and the coarser material is scattered in it, or close to rockfill, if the coarser material touch to each other and the fines occupy the voids left by them. So, an additional parameter must be considered – the coarser material percentage (percentage of retained material in the $\frac{3}{4}$ " sieve from the ASTM series).

In support of this hypothesis, USCOLD (1998) recognizes that the inclusion of rock particles in otherwise fine grained soils can have a significant influence on the engineering properties of the material, depending, among others things, upon the relative percentage of soil and rock present in the mixture. The study mentions that, for mixtures of non cohesive materials (sand and gravel), in a proportion around 20 to 50% of its total weight, an improvement of mixture compaction conditions occurs in relation to the rockfill material, with a consequent improvement of its mechanical properties. This conclusion allowed the

acceptance of the use of this type of materials in dam shells. Nevertheless, for clayey and silty mixtures, according to same authors, more studies are needed.

Relatively to rockfill materials, a laboratory study performed by Veiga Pinto (1983) reveals that the parameters influencing, in an ascendant order, their mechanical behaviour are: rock fragments strength, void ratio and stress state. According to the same author, the void ratio is presently the parameter with lesser and lesser influence, since the actual compaction techniques, which take advantage of powerful cylinders, allows the maximum compactness. On the other hand, the stress state is dependent on the embankment height. So the material behaviour, in properly compacted works, is especially dependent on the rock fragments strength.

For the embankment construction quality control of soil-rock mixtures, the usual practice is to apply corrective expressions to the Proctor test results (optimum water content and maximum dry density), in order to have into account the coarser material influence in the reference properties. Corroborating Veiga Pinto findings for rockfill materials, previous studies carried out with soil-rock mixtures showed a strong dependence between corrective expressions and rock fragments strength.

Having for reference the construction of Odelouca dam, with shells constituted by weathered schist and greywacke, with a significant fraction of oversized particles, a laboratory test program was carried out for the deduction of corrective expressions to apply in the embankment quality control.

3.1. PREVIOUS STUDIES OF SOIL-ROCK MIXTURES COMPACTION

In the soil-rock mixtures embankment construction mixed procedures are adopted: construction techniques employed in the rockfill construction (as crash roller spreading and vibrator roller compaction, with 4.5 kN/m static load per vibration generating line (JAE, 1998)) and construction quality control techniques used in soils embankments, in conjunction with some correction equations properly deduced. Additionally, in order to reduce the energy taken in by the larger particles, maximum dimension is limited to two thirds of the layer thickness (Winter and Suhardi, 1993).

Extraction, transportation, placement, spreading and compaction of these materials induce, in general, a grain size evolution, expressed by fines increasing. In this way, it should be expected that materials resulting from this kind of process were characterized by extensive grain size distribution, high compactness and good mechanical strength. However, this is not always verified because of significant mechanical and physical properties changes caused by construction processes, by atmospheric conditions (such as wetting and drying cycles) and by mechanical actions imposed.

Winter and Suhardi recommend the adoption of different proceedings for compaction control according to the coarser fraction present in the mixture. For materials having less than 45 to 50% of particles larger than 20 mm, the matrix properties (i.e. the fine material in the mixture) will control those of the embankment structure, so its construction control can be carried out through truncated grain size distributions (by elimination of the coarser particles). If

the blocks proportion rises significantly above 45 to 50% of the total mass, then physical and mechanical characteristics based on truncated grain size distributions may not be representative. Large scale testing, including in situ testing, may be necessary. This work allows yet concluding that substantially heavier equipment and/or more passes and/or thinner fill layers are necessary to guarantee high levels of compaction in coarse granular fills than in their finer grained or matrix dominant fills.

Some laboratory (one-dimensional strain compression) and in situ (plate load) tests were performed to assess the mechanical characteristics of soil-rock mixtures in the earthworks of the highway Via Longitudinal do Algarve (VLA). Tests and studies results (JAE/LNEC, 1994) allow verifying that both coarser and finer fractions influence stress-strain behaviour of the soil-rock mixture. Its behaviour was dependent on the material characteristics (such as type (with distinct physical and mechanical properties), heterogeneity, evolutive nature, wetting collapse susceptibility, expansibility and creep) and construction conditions (spreading technique, amount of water present, atmospheric conditions and compaction methodology).

Houston and Walsh (1993) report that, in order to have into account the coarser fraction influence in the quality control, different laboratory compaction tests methodologies can be adopted:

Method 1 (integral sample) – in large moulds, using the integral field material, for maximum dry density and optimum water content evaluation;

Method 2 (scalp-and-replacing) – in moulds of smaller dimensions, removing the plus $\frac{3}{4}$ " (19 mm) material and replacing it with an equal weight of #4 to $\frac{3}{4}$ " material;

Method 3 (eliminating)– using only the material passing $\frac{3}{4}$ " sieve in a 6" (15.24 cm) mould; the plus $\frac{3}{4}$ " material is discarded;

Method 4 (eliminating and correcting) – using only the minus #4 fraction and correcting the results obtained taking into account the percentages of coarser fraction of the field mixtures (through ASTM D4718, Standard T224 or Standard 5515-89 from USBR).

Method 1 is a very expensive and time-consuming technique, therefore, is rarely used. *Methods 2* and *4* are frequently used for materials with 10% to 60% of coarser particles. *Method 3*, valid when the plus $\frac{3}{4}$ " material is less than 10% by weight (ASTM D698), is only suitable to mixtures with reduced percentage of coarser particles and behaviour clearly controlled by the finer matrix.

Table 1 presents the most used correction equations for the determination of the maximum dry density of the integral material.

The corrective r parameters in the AASHTO and USBR formulas are used to compensate the interference of coarser material blocking the finer material (existing between it) compaction. The ASTM expression doesn't have any corrective parameter, but its application is limited to a coarser fraction lesser than 40%.

Table 1 – Most used corrective equations (adapted from Houston and Walsh, 1993)

Equation designation	Reference	Equation	Comments
AASHTO - 1	AASHTO T224 (1982)	$\gamma_{d\ max}^T = (1 - P_C)\gamma_{d\ max}^F + 0,9P_C\gamma_w G_M$	$\gamma_{d\ max}^F$ determined using methods A or B, AASHTO T99 or T180.
AASHTO - 2	AASHTO T224 (1982)	$\gamma_{d\ max}^T = \frac{\gamma_w}{\frac{P_C}{G_M} + \gamma_w \frac{1 - P_C}{r_A \gamma_{d\ max}^F}}$	$\gamma_{d\ max}^F$ determined using methods A or B, AASHTO T99 or T180. Correction factor r_A depends on coarser fraction.
ASTM	ASTM D4718 (2001)	$\gamma_{d\ max}^T = \frac{\gamma_w}{\frac{P_C}{G_M} + \gamma_w \frac{1 - P_C}{\gamma_{d\ max}^F}}$	$\gamma_{d\ max}^F$ determined using ASTM D698 or D1557.
USBR	USBR 5515-89 (1990)	$\gamma_{d\ max}^T = \frac{\gamma_w}{\frac{P_C}{G_M} + \gamma_w \frac{1 - P_C}{r_u \gamma_{d\ max}^F}}$	$\gamma_{d\ max}^F$ determined using method 5500-89 from USBR. Correction factor r_u depends on coarser fraction and fines composition (clayey, silty or sandy).

$\gamma_{d\ max}^T$ – Maximum dry density of total material;

$\gamma_{d\ max}^F$ – Maximum dry density of the finer fraction;

G_M – Solid particle density of the coarser fraction;

P_C – Percent by weight of the coarser fraction;

r_A – Correction factor to account for interference of coarser particles in AASHTO equation;

r_u – Correction factor to account for interference of coarser particles in USBR equation.

Studies, carried out by LNEC (1987), suggest the use of the scalp-and-replacing method and the correction of the values obtained in the compaction tests, w_{opt}^F and $\gamma_{d\ max}^F$, to calculate the optimum water content and the maximum dry density of the mixture, as a function of the percentage of the coarser particles (retained in #4 or in $\frac{3}{4}$ " sieves of the ASTM series), as follows:

$$\gamma_{d\ max}^T = \frac{100}{\frac{P_C}{\gamma_d^C} + \frac{P_F}{\eta \gamma_{d\ max}^F}} \quad (1)$$

$$w_{opt}^T = \frac{P_F w_F + P_C w_C}{100} \quad (2)$$

where $\gamma_{d\ max}^T$ and w_{opt}^T is the maximum dry density and the water content of the total material, γ_d^C and w_C the dry unit weight and water content of the coarser fraction, P_F and w_F the percentage in weight and the water content of the finer fraction (usually taken as w_{opt}^F obtained in the compaction tests), P_C the percentage in weight of coarser fraction and η a correction coefficient, defined as:

$$\eta = -5 \times 10^{-5} P_C^2 + 0.0013 P_C + 0.9958 \quad (3)$$

In 1994, Torrey and Donaghe introduced a new method, calibrated from data till then published for soil-rock mixtures. They performed standard effort compaction tests in different moulds and with materials composed by gravel, sand and non plastic silts or high plasticity clays. For the result treatment, they defined two additional quantities -the density interference coefficient, I_c , and the optimum water content factor, F_{opt} , expressed as:

$$I_c = \frac{100F_F}{P_C G_M} \quad (4)$$

$$F_{opt} = \frac{100w_{opt}^F}{P_C W_{opt}^T} \quad (5)$$

where F_F is the fraction density factor, given by $F_F = \gamma_d^F / \gamma_d^{F_{máx}}$, γ_d^F the dry unit weight of the finer fraction and G_M the soil particles density of the coarser fraction.

To calculate F_F , the authors appealed to the following equation:

$$F_F = \frac{\gamma_d^{T_{máx}} G_M \gamma_w P_F}{100 \gamma_d^{F_{máx}} G_M \gamma_w - \gamma_d^{T_{máx}} \gamma_d^{F_{máx}} P_C} \quad (6)$$

The values of I_c and F_{opt} of each test were represented as a function of coarser content, P_C . This representation allowed to verify that the proposed parameters were independent of type of fines present and to suggest correlations between these parameters and the coarser fraction, P_C .

Besides the methods based on physical properties, there are, in the specialized bibliography, others soil-rock mixtures control methods based on the deformability characteristics. Maranha and Veiga Pinto (1983) refer to the soil-rock mixture control method use in Meimoa Dam, which consisted in performing one-dimensional strain compression tests, on 230 mm diameter samples, with two different dry density values (approximately 20 and 21.5 kN/m³), three water contents (between 4 and 11%) and several coarser fractions. The authors intended to control the material oedometric modulus in order to assure values between 30 and 40 MPa, so that stiffness contrast between core and downstream shell placed materials was low (Figure 8).

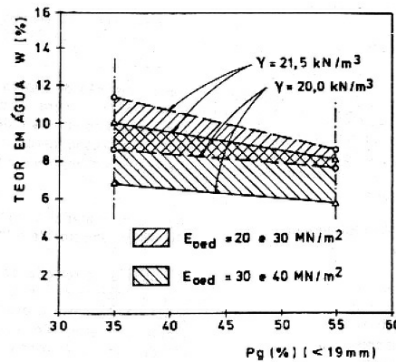

Figure 8 – Correlations between water content, dry density, percent of coarser fraction and oedometric modulus for Meimoa dam (JAE/LNEC, 1994)

3.2.1 COMPACTION CONTROL BASED ON VIBRATORY TESTS

During the trial embankment construction, LNEC proposed a laboratory testing program for setting up corrective expressions to extrapolate the properties obtained by truncated grading to the actual grading size, according to Torrey and Donaghe (1994) methodology. It was admitted that the expressions derived by these authors for gravel, sand, silt and clays mixtures would not be directly applicable due to evolutive nature of the shell material.

In view of the compaction equipment (vibrating roller) used in the dam, laboratory vibratory compaction tests of the integral material were carried out and compared with the Proctor reference values. LNEC have a vast experience in application of vibration in samples reconstitution and preparation for triaxial compression test in rockfill materials, so similar procedures were used to assess the compaction curves for soil-rock mixtures.

After prior material extraction and homogenization for trial embankments construction, different samples were collected from different lots. The vibratory tests were performed based on specifications, suitably adapted, reported in part 4 of the BS1377, 1990, entitled "British Standard Methods of test for Soils for Civil Engineering Purposes: Part 4. Compaction-related test: 1990". The standard uses the following equipment: a CBR mould, an electric vibrating hammer, a steel tamper for attachment to the vibrating hammer, a device enabling sample depth measurement and a stop-clock.

The (310 mm inside diameter and 300 mm high) cylindrical mould available (Figure 11), is sectioned longitudinally, connected with rigidity ribs, and fixed to a metal base, in order to be easily removable and transportable. For the compaction, a hammer coupled to a (300 mm diameter, 20 mm thick and 100 N weights) plate of steel was used (see Figure 11). The gap between the mould and the plate is about 10 mm. The total force exerted, including the hammer and plate weights, reaches 2,954 N. In view of the mould diameter (300 mm), the maximum dimension of the mixture particles was limited to 2", and tests have been performed (Brito, 2006) with varying percentages of the coarser fraction (material retained in $\frac{3}{4}$ " sieve) present in the mixture (Figure 12).



Figure 11 – a) Electric vibrating hammer and mould; b) cylindrical mould

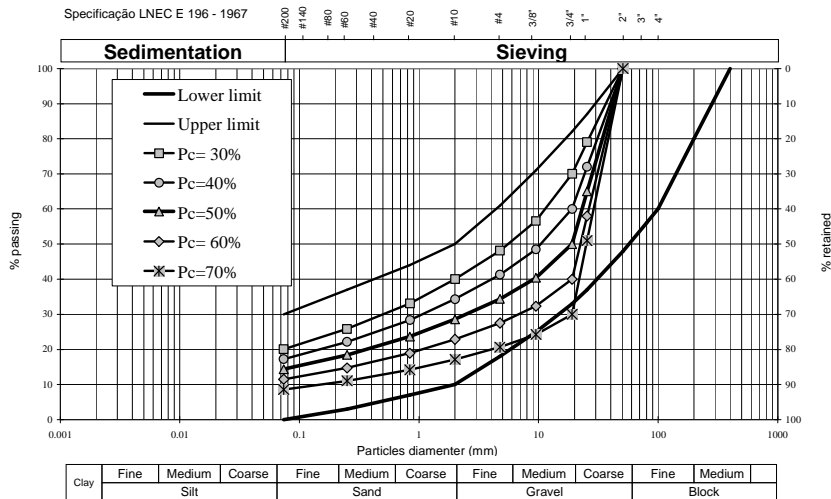

Figure 12 – Grain size distributions of mixtures with particles limited to 2” with varying percentages of the coarse fraction

During compaction, the thickness variation as function of vibration time was measured and some observations can be drawn: (i) for high values of the water content and high vibration times, fine materials reflux occurred systematically; (ii) for the higher water content tested (13.8%), after about 2 minutes of vibration, some swelling was detected, possibly due to material segregation, consequently, with a reduction of its dry density; (iii) for the remainder tests, regardless of water content, the maximum dry density was reached after nine minutes of vibration.

To validate the use of vibration tests in the compaction study, the results obtained through this procedure were compared with the conventional Proctor tests, performed for the material passing $\frac{3}{4}$ ” sieve.

The results as function of the vibration time are displayed in Figure 13 and compared with the compaction curve obtained in the standard Proctor test. This figure analysis allows concluding:

- for the dry side of the compaction curve and for a water content deviation larger than 1%, it is not possible to achieve, by the vibration process, dry densities comparable to those obtained by the standard process, regardless of the vibration time;
- for the wet side of the compaction curve and for high water content, the vibration process had to be stopped after some time of vibration due to the occurrence of reflux;
- for small water content deviations in the wet side, some segregation of materials was produced, reaching the maximum dry density after only about 2 minutes of vibration;
- the values of dry density and optimum water content obtained by vibration after 9 minutes and by standard compaction are practically coincident.

dent, so one may conclude that, in this instance, the energy applied are equivalent;

- the curve obtained by standard compaction presents a far more flattened shape than the one obtained after 9 minutes of vibration, so, the identification of the optimum point is facilitated in the vibration procedures.

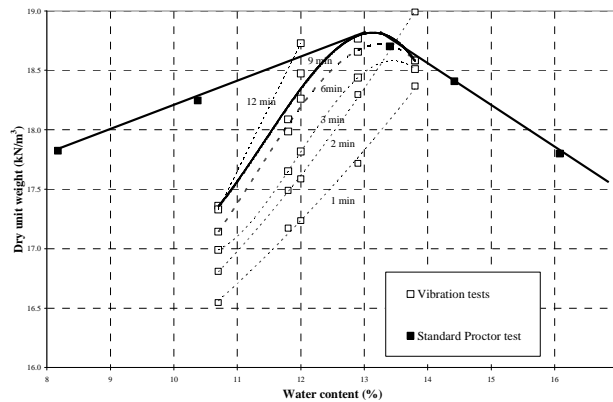

Figure 13 – Comparison of the compaction curves obtained by vibration and by the standard Proctor test (Caldeira and Brito, 2007)

Then, vibration compaction tests, with different percentages of coarse fraction (between 30 and 67.7%), were performed using the available lots. The compaction curves obtained after nine minutes of vibration, with different percentages of coarser fraction are represented in Figure 14. The optimum points, considered in the interpretation of the testing that follows, are also marked.

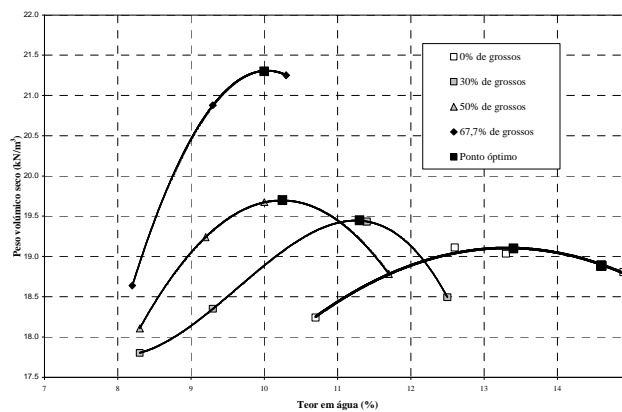

Figure 14 – Joint representation of compaction curves, after nine minutes of vibration, and their optimum points

3.2.2 COMPACTION CONTROL BASED ON STANDARD PROCTOR TESTS

For comparison, conventional standard compaction Proctor tests were also performed with different coarser fractions.

The second test program was performed in a large-scale compactor (Toni-tecnik), using different coarser fractions to obtain the maximum dry density and the corresponding optimum water content.

The standard Proctor compaction tests were carried out in an appropriate dimension mould, larger than the conventional moulds of the standard tests, in the Toni-tecnik compactor (Figure 15). Naturally, it was necessary to adapt the standard procedures E 197-1966, due to the equipment and samples scope. So, tests were performed to assess the number of layers and the number of blows per layer. In order to have the same effort of the standard compaction test, the compaction was carried out by the application of 55 blows per layer, in three layers.

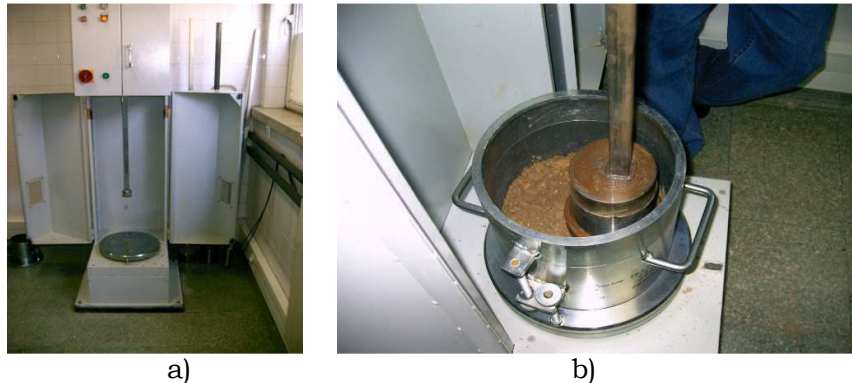

Figure 15 – a) Toni-tecnik compactor, b) mould and the pestle use in the standard compaction tests.

The compaction curves obtained, as well as the reference test optimum point performed with soil constituted only by the finer fraction, are presented in Figure 16.

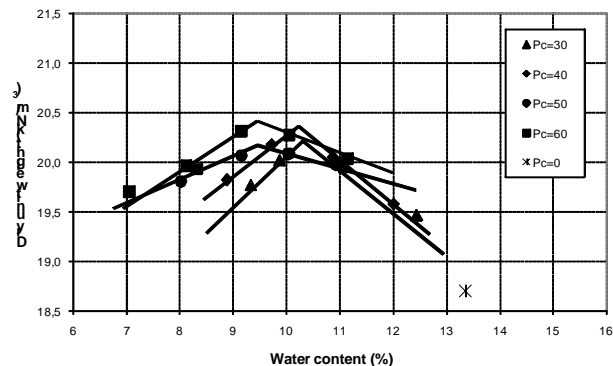

Figure 16 – Compaction curves from standard compaction tests

As one can realize, the maximum dry density values are all between 20.2 to 20.3 kN/m³, not varying with the coarser fraction. With regard to the water content, larger variations occur, being the higher value recorded for the mixture with the higher percentage of fines, as it would be expected, since the finer fraction can absorb higher amount of water than coarser fraction.

The comparison of Figures 14 and 16 allows concluding that the vibration compaction method is more efficient for these materials than the standard method, causing larger reduction of the voids of the mixture, probably, due to the changes in arrangements of the coarser particles.

3.2.3 – CORRECTIVE EQUATIONS

Torrey and Donaghe (1994) approach was adopted in tests results analysis. The values of interference coefficient of the dry density, I_c , and the corrective factor of the optimum water content, F_{opt} , have been evaluated.

A higher correlation data for the tests was found when a bi-logarithms relationship is adopted between I_c and F_{opt} and the coarser fraction, P_C , as follows, for vibratory tests:

$$\log I_c = 1.7193 - 1.0802 \log P_C(\%) \quad (R^2 = 0.9929) \quad (7)$$

$$\log F_{opt} = 1.873 - 0.845 \log P_C(\%) \quad (R^2 = 0.9769) \quad (8)$$

and, as follows, for standard Proctor tests:

$$\log I_c = 1.9067 - 1.1909 \log P_C \quad (R^2 = 0.9983) \quad (9)$$

$$\log F_{opt} = 1.8535 - 0.8291 \log P_G \quad (R^2 = 0.9983) \quad (10)$$

Some water content determinations were made for each fraction present in the mixture. A small oscillation of the coarser fraction water content relatively to the average value (equal to about 4.7%) was evidenced. This variation practically turned out to be independent from the water content of the integral material.

To improve the correlation between the experimental results and the interpolation expression of the corrective factor of the optimum water content, it was considered relevant to test a new methodology. The coarser fraction water content was assumed constant. On the basis of the optimum water content of the total material, the water content of the finer fraction was evaluated and the following expressions derived, respectively, from the vibratory and standard compaction tests:

$$w_F = 319.17 P_G^3 - 406.84 P_G^2 + 177.15 P_G - 11.369 \quad (R^2 = 0.9809) \quad (11)$$

$$w_F = 26.071 P_G^2 - 12.793 P_G + 14.412 \quad (R^2 = 0.9801) \quad (12)$$

It shall be noted that this water content values can be compare directly with water content of the finer fraction.

As mentioned before, the tests had been carried with coarser fractions between 30 and 67.6%. In the sense of validate the tests application conditions, Figure 17 shows fraction density factor and maximum dry unit weigh of the

total material versus the percent coarser fraction obtained using the original Torrey and Donaghe equation and equations (1), (7) and (9).

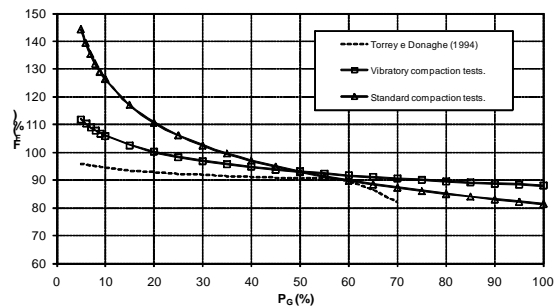

a)

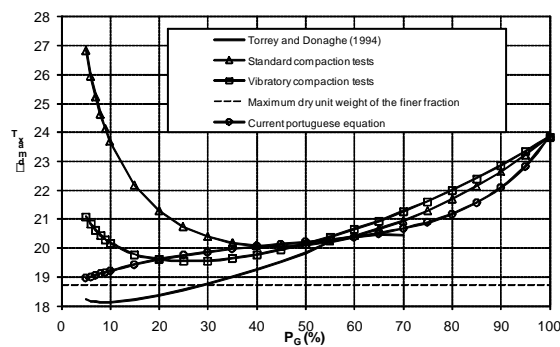

b)

Figure 17 – a) Fraction density factor; b) maximum dry density of integral material versus coarser fraction

The figures analysis allows concluding that expressions (7) and (8) present fraction density factor values higher than 100%, for percent coarser fractions inferior to 20%, in the vibratory compaction tests, and 35%, in the standard compaction tests, which does not seem to have any real counterpart. For these percentages of coarser fractions, it's verified that the maximum dry density of the total material is practically equal to the dry density of the finer fraction corrected for the presence of coarse particles. In the remaining domain, the curves have a very regular path and exceeding the Torrey and Donaghe expression. In terms of maximum dry density of the total material, the values, now deduced, are always larger than the maximum dry density of the finer fraction, obtained in the standard Proctor test. These results are the consequence of the presence, in the interior of the finer matrix, of coarser particles with higher density.

Figure 18 presents optimum water content of total material as function of the coarser fraction based on Torrey and Donaghe expressions and equations (8), (10) to (12). The results calculated from the equations (10) to (12) show that the optimum water content of the total material is always monotonically decreasing with the percent coarser fraction, being the values gotten for the Odelouca mixtures always superiors to the deduced ones for Torrey and Donaghe. For higher coarser fraction percentages, the curves tend asymptotically to water contents (of 5.9%, Torrey and Donaghe expression, 8.5%, expression

(10), and of 8.8%, expression (8)) well superior to the gotten ones for the coarser fraction (about 4.7% on average). Thus, one suggests that the field of application of these expressions is limited inferiorly to 10% of coarser fraction and superiorly to 70%.

The alternative expression (11) presents a very different path from the remains, especially for extreme percentages of coarser fractions (reduced or very high). Comparing with the previous expressions, it will have some meaning from 25% until about 65% of percent coarser fraction, not seeming believable for superior percentages, where the curve evolves, first, in an ascending way, quickly descending, until the water content of the coarser fraction. The alternative expression (12) has similar course to expressions (8) and (10) until percentages of about 65% coarser fractions, starting to evolve in a descending way to the water content of the coarser fraction. Thus, it is suggested that the application field of this expression is limited only inferiorly to 10% of coarser fraction, being able to be applied in the remaining domain.

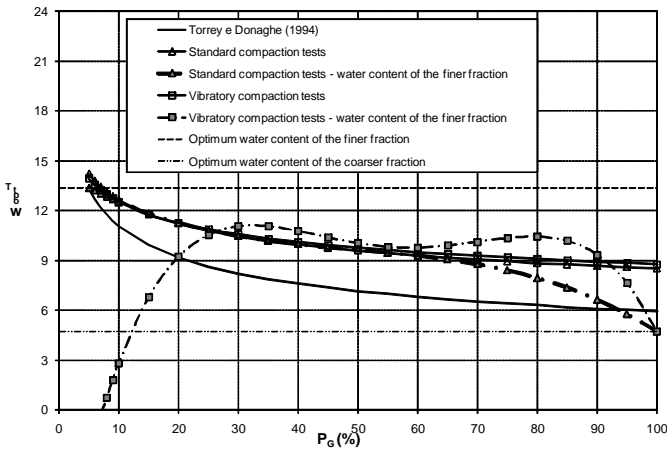

Figure 18 – Optimum water content of total material as function of the coarser fractions

4. CONSTRUCTION OF ODELOUCA DAM

The grain size distributions of the shell materials of the dam tested during construction are represented in Figure 19, as well as the granulometric range defined in the design. In the contact zones with the core, finer materials were employed.

The construction quality control of the compacted layers was done by the application of Hilf's method (Hilf, 1959) to the fraction of the soil-rock mixture passing #4 sieve. Hilf's method allows the evaluation of the degree of compaction and optimum water content deviation without the previous knowledge of the corresponding water content, as well as the ignorance of the standard Proctor reference curve. It also allows, with certain closeness, to justify the decision of acceptance or rejection of layers within a sufficiently short term,

without causing significant disruptions or interruptions to the construction work.

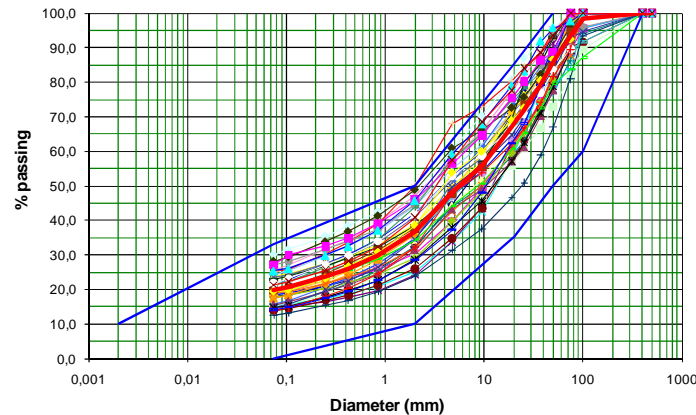

Figure 19 – Grain size distribution of shell materials of Odelouca Dam

Basically, the procedure consists in performing an in situ sand cone test for the density determination of the layer in analysis. Then, the material collected is taken to the laboratory. The sample is divided in at least three specimens. One specimen, with the in work placing water content, is compacted with the standard effort and the respective unit weight is determined. In a proper graphic (Figure 20), the obtained density value is plotted in the 0% of water content deviation vertical line (point A). Next step consists in adding to the second specimen about 2% of weight of water and to perform a new compaction, in aim of the new density determination. The new density value, referred to in situ water content (transformed density), is plotted in the +2% of water content deviation vertical line in the graphic (point B).

The determination of a third point (point C) depends on the relative position of points A and B. If point B has a density higher than point A, a 4% of material weight of water is added to the third specimen. A new compaction is performed and the corresponding density is evaluated. Dividing this value for 1.04, one finds out the density referred to the natural water content (point C). The correspondent value is plotted in 4% deviation vertical line, in the same graphic. On the other end, if point B has a transformed density inferior to point A, the specimen should be dried (in about 2% of its weight) to perform a new compaction. The three points obtained are sufficient to define a parabolic curve, corresponding to the transformed density related to the in work placing water content, if the endpoints have ordinates below the midpoint. Otherwise it's necessary to perform another compaction, with a different quantity of water, to determine a fourth point. After that, the three points closer to the maximum transform density must be chosen. Through these points a vertical axis parable (named the transform wet density curve) should be drawn and its peak coordinates are calculated (point with the maximum density).

The degree of compaction (D) and the compaction efficiency (C) are then evaluated by the following expressions:

$$D = \frac{\text{In situ density}}{\text{Density corresponding to the parable peak}} \quad (13)$$

$$C = \frac{\text{In situ density}}{\text{Density at 0\% deviation water content}} \quad (14)$$

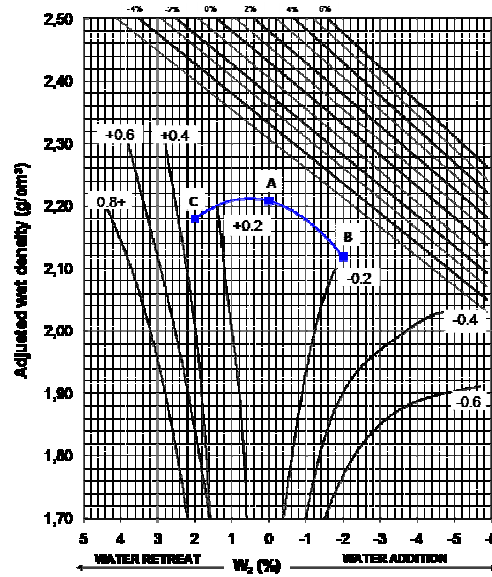

Figure 20 – Hilf's method graphic

The difference between the optimum water content and the in situ water content is the abscissa of the parabola peak. This value is corrected by adding the indicated value in the curve closest to the peak, taking into account the correction sign.

This method is relatively quick and easy to use and is therefore widespread in the compaction control of embankments. Nevertheless, the method only provides relative magnitudes (of compaction degree and water content deviation). So, it is common to complement it with the overnight oven determination of the in situ water content and the specimens' water content after compaction tests, which allows the assessment of the dry density and establishment of the compaction curve based on three points.

Hilf's method was developed only for fine soils. So, in order to set the applications conditions and the applicability of this method to soil-rock mixtures, a testing program was implemented. First step consisted in performing a standard Proctor test to establish the reference compaction curves for the passing material in the 3/4" sieve, from the ASTM series, and for the passing in the #4 sieve. After the determination of the Proctor reference curve, Hilf's method was applied, in laboratory, simulating for three in situ water contents, differing approximately 1% from each other, for the two material gradations.

The tests performed in laboratory allow concluding that: (i) Hilf's method is applicable indifferently for the material passing 3/4" sieve and #4 sieve, (ii) it is

capable of identify correctly the samples in the wet and dry sides of the compaction curve, (iii) the water content deviation error is lesser than 0.9%, even when the water content exceeds 2%, (iv) the compaction degree is correctly determined with an error inferior to 0.01.

The results obtained during the compaction control of the different layers of the upstream and downstream shells of Odelouca dam (current and core contact zone) by the application of the Hilf's method and the deduced corrective expressions for soil and rock mixtures are represented, in histogram form, in terms of compaction degree and water content deviation, in Figures 21 and 22. They show that the materials were compacted in the wet side of the compaction curve for both shells and that a good compaction was achieved, with lower characteristics values of compaction degree and water content deviation of 98% and -0.4%, for the upstream shell, and of 96% and 0.4%, for the downstream shell.

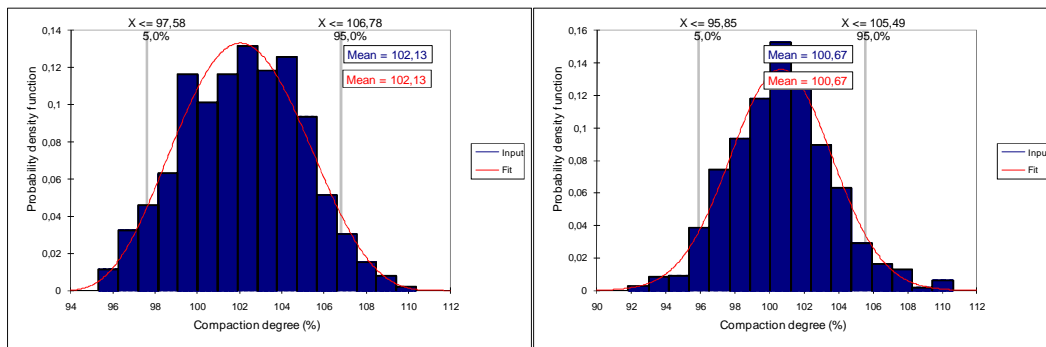

Figure 21 – Histogram and density probability functions of the compaction degree of Odelouca dam: a) upstream shell; b) downstream shell.

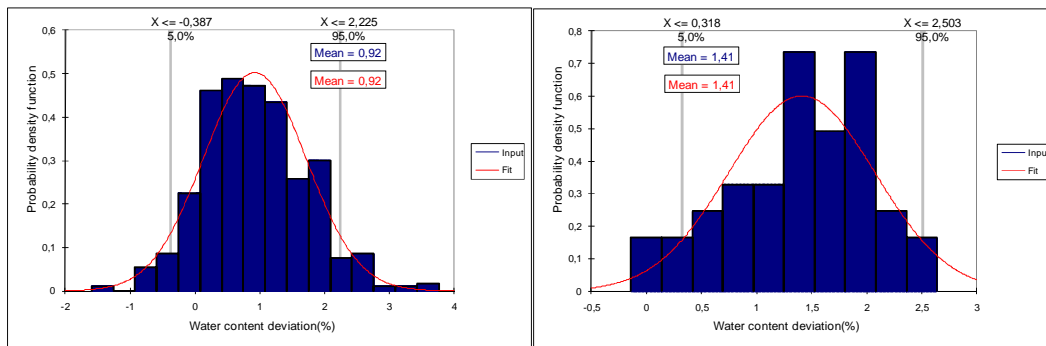

Figure 22 – Histogram and density probability functions of the water content deviation of Odelouca Dam: a) upstream shell; b) downstream shell

The internal vertical displacements registered during the construction in a settlement gauge located in the central (higher) part of the dam are represented in Figure 23. The accumulated settlements during construction attained a maximum value around 1100 mm. Examining the incremental settlements of the different layers between the measuring points, it is observed that the major contribution of the layers between elevations 75.00 and 78.00 m (280 mm) and between elevations 66.00 e 69.00 m (235 mm), and the dif-

ferent stiffness of the layers in the central third of the dam. It is expected the major settlement will be in this region, but not presenting the stiffness contrast as shown in Figure 23. This effect could be in fact caused by different compaction characteristics of the layers or/and due to the exposure to severe atmospheric conditions.

The comparison of construction settlements of Odelouca and Beliche dam, allows to conclude that the maximum value is of the same order of magnitude, taking to account the different heights of the dams. Nevertheless, the progression of the settlements is more regular in Odelouca. After heavy rains, the settlements only increased in the exposed layer and it did not affect the remaining embankment. As the compaction was done with water content larger than the optimum, lesser displacements than the ones observed in Beliche and Meimoa are expected for Odelouca dam during the first filling of the reservoir.

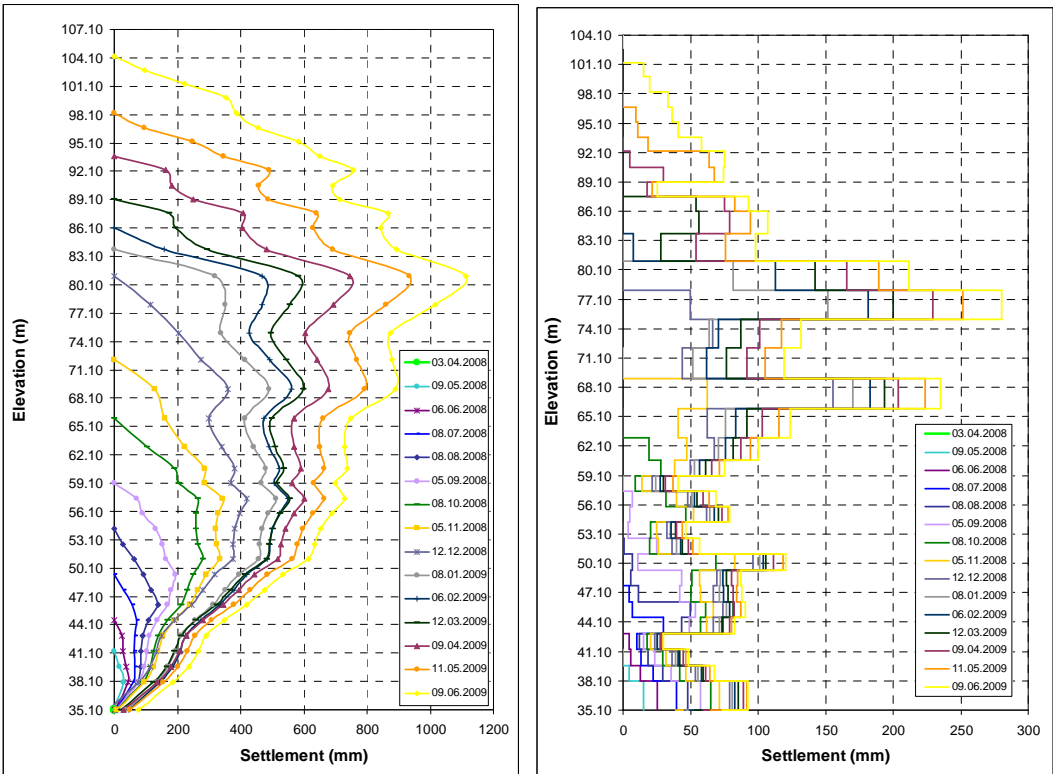

Figure 23 – Settlements during Odelouca dam construction: a) accumulated; b) incremental

3. CONCLUSIONS

Having for reference the shells of Odelouca dam, this paper presents results from vibratory and standard compaction tests, carried out for the deduction of corrective expressions to apply in the embankment quality control in soil-rock mixtures.

The Torrey and Donaghe (1994) methodology was adopted in the tests results analysis and correlation equations were established for the determination of the maximum dry density and the optimum water content of the integral material and the optimum water content of the finer fraction as function of coarser fraction percentage. A comparison of the different expressions is here present, as well as, the conditions of application of each one.

In terms of maximum dry density, as it could be expected, it can be seen that the standard process is more efficient in mixtures with a small coarser percentage and the vibratory compaction otherwise. Normally, in the field, the soil-rock mixtures are compacted with vibratory rollers. Thus, the equations derived with the vibratory tests should be used. The most used expressions used in Portugal show some differences in relation to the one's here deduced.

These corrective expressions and Hilf's method were applied for quality control during the construction of Odelouca dam. The shell materials were compacted in the wet side of the compaction curves. In this dam, the settlements during the construction phase presented the same order of magnitude of Beliche dam. Nevertheless, lesser displacements than the ones observed in Beliche and Meimoa are expected for Odelouca dam during the first filling of the reservoir.

REFERENCES

American National Standard – ASTM – D4718-87 (2001). *Standard Practice for Correction of Unit Weight and Water Content for Soils Containing Oversize Particles*.

Brito, A. (2006). *Compactação de aterros de barragens. Novas Metodologias de Controlo*. Tese de mestrado de Geotecnia para Engenharia Civil, Instituto Superior Técnico.

Caldeira, L. e Brito, A. (2007). *Controlo da compactação de misturas de solo-enrocamento da barragem de Odelouca através de ensaios de vibração*. Revista Luso-Brasileira de Geotecnia N.º.109, Março de 2007, pp.43-75.

JAE/LNEC (1994). *Controlo de Construção e Caracterização Físico-Mecânica de Aterros de Mistura de Solo-Enrocamento*. Fevereiro de 1994.

JAE (1998). *Normas da Junta Autónoma de Estradas*. Lisboa, 1998.

Hilf, J. W. (1959). *A Rapid Method of Construction Control for Embankments of Cohesive Soil*. Engineering Monograph No.26, Bureau of Reclamation, p.23.

Houston, S. L. and Walsh, K. D. (1993). *Comparison of Rock Correction Methods For Compaction of Clayey Soils*. Journal of Geot. Eng., Vol.119, N.º4, 763-778, April.

LNEC (1987). *Aterros com Misturas de Solos e Enrocamentos. O Caso Particular dos Xistos Alterados Existentes em Portugal*.

Maranha Neves, E. and Veiga Pinto, A. (1983). *Compaction Control and Random Fill Materials*. 8th Europ. Conf. on SMFE, Helsínquia.

Maranha das Neves, E. (1993). *Fills and Embankments*. General Report, Int. Symposium on Hard Soils and Soft Rocks, Athens, Vol.3, Sept.

NPB (1993). *Normas de Projecto de Barragens*.

Pardo de Santayana, Fernando (2006). *Structural Behaviour of Beliche Earth-Rock Dam After Rehabilitation Works*, 22nd Congress of Large Dams, Barcelona, Spain.

Torrey, V. H. e Donaghe, R. T. (1994). *Compaction Control of Earth-Rock Mixtures: A New Approach*. Geotechnical Testing Journal, ASTM, VOL.17, No. 3, September 1994, pp. 371-386.

USBR 5515-89 (1989). *Procedure for Performing Laboratory Compaction of Soils Containing Gravel*. U.S. Dept. of the Interior. Bureau of Reclamation. Denver. Colo.

USCOLD (1998). *Construction Testing of Embankment Materials Containing Large Particles*. U.S: Committee on Large Dams, April 1988.

Veiga Pinto, A. (1983). *Previsão do Comportamento Estrutural de Barragens de Enrocamento*. Tese para obtenção do grau de especialista. Lisboa, LNEC.

Winter, M.G.; Suhardi (1993). *The Effect of Stone Content on the Determination of Acceptability for Earthworking*. Proc. Conf. Engineered Fills. University of Newcastle upon Tyne. 312-319.